

**BA684DF-P  
PROFIBUS PA  
Field mounting  
Fieldbus Display**

Issue: 3

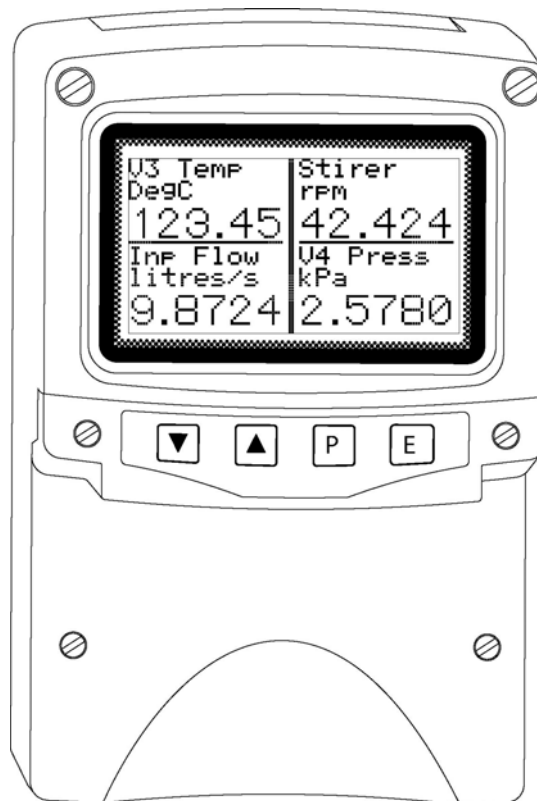

## CONTENTS

### 1. Description

- 1.1 Documentation
- 1.2 Version 3.0 firmware

### 2. Operation

- 2.1 Controls

### 3. System Design

- 3.3 External switches
- 3.4 Alarm outputs

### 4. Installation

- 4.1 Location
- 4.2 Installation procedure
- 4.3 EMC

### 5. Display & Alarm Configuration

- 5.1 Default configuration
- 5.2 Accessing the display configuration menus.
- 5.3 Configurable functions
  - 5.3.1 Screens (Display format)
  - 5.3.2 Input Settings
  - 5.3.3 Tags
  - 5.3.4 Units
  - 5.3.5 Alarms
    - 5.3.5.1 Alarm Summary
    - 5.3.5.2 Alarm Activation
    - 5.3.5.3 Alarm Output
  - 5.3.6 Display
    - 5.3.6.1 Settings
    - 5.3.6.2 Quick Access
    - 5.3.6.3 Access Code
    - 5.3.6.4 Status Text
    - 5.3.6.5 Last input
  - 5.3.7 Keys
  - 5.3.8 Code
  - 5.3.9 Unit Info
  - 5.3.10 Defaults
    - 5.3.10.1 Display Defaults
    - 5.3.10.2 Interface Board Default
  - 5.3.11 Instrument address
- 5.4 Quick Access Menu

### 6. Maintenance

- 6.1 Fault finding during commissioning
- 6.2 Fault finding after commissioning
- 6.3 Servicing
- 6.4 Routine maintenance
- 6.5 Guarantee
- 6.6 Customer comments

### 7. Accessories

- 7.1 Tag plate
- 7.2 Pipe mounting kits
- 7.3 PROFIBUS Interface Guide

### 8. Index

## 1. DESCRIPTION

The BA684DF-P PROFIBUS Display can simultaneously display up to eight PROFIBUS PA process variables, together with their units of measurement and tag information. The instrument is bus powered so no additional power supply is required.

Order Code	Communication Protocol	Function Blocks
BA684DF-P	PROFIBUS PA	Eight Analogue outputs (8 x AO)  Six Digital inputs (6 x DI)

The instrument's communications protocol is shown on a label inside the terminal cover. The '-P' order code suffix also indicates the protocol but is not shown on the instrument identification label. There is an alternative version of the fieldbus display, order code BA684DF-F for use on FOUNDATION™ fieldbus systems.

Configuration may be performed by either a DPV 0 user PRM data download, or by a DPV 1 configurator and if required the instrument address may be entered via the instrument's front panel push buttons. The required GSD files are available for downloading from both the PROFIBUS and BEKA websites.

Eleven selectable standard display formats enable one, two, three, four or eight process variables, some with bargraphs to be displayed simultaneously on one screen.

The four front panel push buttons that control the instrument display may also be used for returning operator acknowledgements, thus enabling the BA684DF-P PROFIBUS display to function as a simple operator interface. If larger industrial push buttons are required for entering these acknowledgements, up to six external switches may be connected to the BA684DF-P. These switch inputs may also be used for returning the status of plant contacts to the host using the DI function blocks.

The BA684DF-P PROFIBUS display can be supplied with six optional alarm outputs that may be linked to any of the displayed fieldbus variables. These alarm outputs are locally activated from the fieldbus variable and are configured via the instrument menus and push buttons. They can not be controlled via the fieldbus.

Housed in a robust IP66 glass reinforced polyester (GRP) enclosure with a toughened glass window, the BA684DF-P is surface mounting, or may be pipe mounted using one of the accessory kits.

## 1.1 Documentation

This instruction manual describes system design, conditioning and installation of the BA684DF-P PROFIBUS display. For detailed commissioning information please refer to the PROFIBUS Interface Guide that can be downloaded from the BEKA website [www.beka.co.uk](http://www.beka.co.uk)

## 1.2 Version 3.0 firmware

This manual describes BA684DF-P PROFIBUS displays employing version 3.0 firmware that was released in July 2010 and is not backwards compatible with earlier versions.

Version 3.0 firmware provides

- Addition of (6 x DI) function blocks to return switch status to host.

- Fieldbus address entry via instrument push buttons.

- Addition of DPV 0 configuration

- Addition of two standard screens allowing eight fieldbus variables to be simultaneously displayed.

- Removal of text display facilities

- When using the ▼ or ▲ button to select input, or groups of inputs to be displayed, unused inputs can now be skipped.

The instrument's firmware version can be established using the 'Unit Info' function in the main configuration menu – see section 5.3.9 of this manual. Version 3.0 firmware is shown as SW480F-02-300.

For BA684DF-P PROFIBUS displays employing version 2.0 firmware, please refer to the BA684DF field mounting fieldbus display Issue 6 manual dated 8<sup>th</sup> May 2006 which may be downloaded from the obsolete products section of the BEKA website.

## 2. OPERATION

Fig 1 shows a simplified block diagram of the BA684DF-P PROFIBUS display. When the optional alarms and external switches are not used, the instrument only requires a two-wire connection to the fieldbus.

How much of the BA684DF-P PROFIBUS display configuration can be performed via the fieldbus depends upon the system host. Parameters that can not be configured via the fieldbus can be set using the configuration menu shown in Fig 6 and the four front panel push buttons.

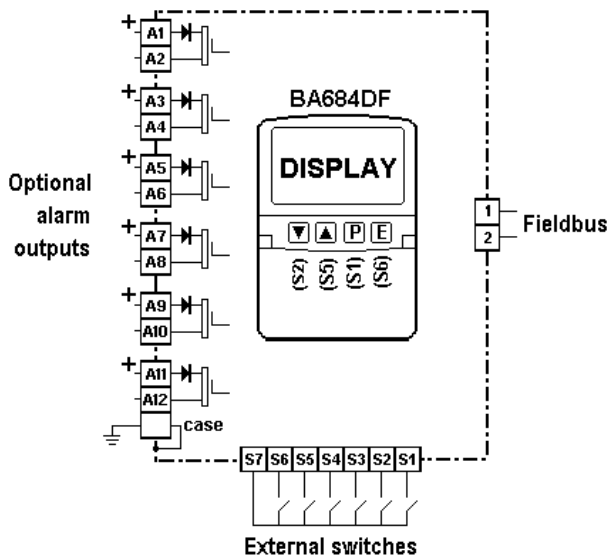

Fig 1 Simplified block diagram of BA684DF-P

### 2.1 Controls

The user can scroll through the display screens by operating the ▼ or ▲ push buttons. The number of screens available depends upon how the BA684DF-P PROFIBUS display has been configured and the number of process variables that are to be displayed. If one fieldbus variable per screen has been configured and eight variables are to be displayed, eight screens will be present; if two fieldbus variables per screen have been configured and six variables are to be displayed, three screens will be available.

If enabled, operating the **P** and ▲ push-buttons simultaneously activates the Quick Access Menu, allowing the user to adjust the display contrast without providing access to any of the other configuration parameters. Additional security may be provided by an optional access code.

### 3. SYSTEM DESIGN

The BA684DF-P PROFIBUS display may be connected to any fieldbus segment as shown in Fig 2, providing it can supply the additional 25mA required to operate the display.

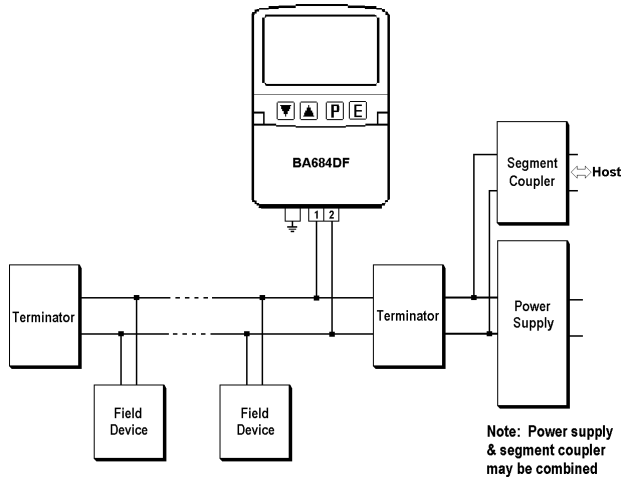

Fig 2 Fieldbus system

#### 3.1 External switches

For applications requiring operator inputs to be made by large industrial push buttons, terminals S1 to S7 allow up to six external switches to be connected to the PROFIBUS display. When external switches are connected, the front panel push buttons may be operated in parallel or disabled – see section 5.3.7.

The BA684DF-P inputs S1 to S7 for external switches are not electrically isolated from the fieldbus terminals, switches and wiring must therefore be isolated from earth and all other electrical circuits.

For reliable operation it is recommended that the cable connecting the PROFIBUS display to external switches less than 5m long.

#### 3.2 Alarm outputs

The BA684DF-P can be supplied with six alarm outputs that may be linked to any of the displayed variables. Each alarm output is a galvanically isolated single pole solid state switch output as shown in Fig 3.

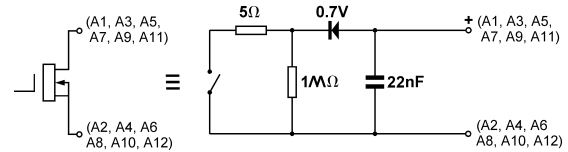

Fig 3 Equivalent circuit of each switch output

The outputs are polarised and current will only flow in one direction. Odd numbered terminals should be connected to the positive side of the supply.

$$\begin{aligned} R_{on} &= 5\Omega + 0.7V \\ R_{off} &= \text{greater than } 1M\Omega \end{aligned}$$

**Note:** Because of the series protection diode, some test meters may not detect a closed alarm output.

#### WARNING

**These Alarm Outputs should not be used for critical safety applications such as an emergency shut down system.**

When the BA684DF-P is disconnected from the fieldbus, or the fieldbus is de-energised, all the alarm outputs will open irrespective of how they have been configured.

## 4. INSTALLATION

### 4.1 Location

The BA684DF-P PROFIBUS display is housed in a robust IP66 glass reinforced polyester (GRP) enclosure incorporating an armoured glass window and stainless steel fittings. It is suitable for exterior mounting in most industrial environments, including off-shore and waste water treatment installations. Please consult BEKA associates if high vibration is anticipated.

The BA684DF-P enclosure is surface mounting. Accessory kits described in sections 7.2 of this manual enable the instrument to be mounted onto a vertical or horizontal pipe.

The field terminals and the two mounting holes are located in a separate compartment with a sealed cover allowing the instrument to be installed without exposing the display assembly.

The BA684DF-P earth terminal is connected to the carbon loaded GRP case. If the case is not bolted to a post or structure connected to the plant potential equalising network, the instrument's earth terminal should be connected to the potential equalising network.

The BA684DF-P enclosure is supplied with a bonding plate to ensure electrical continuity between the three conduit / cable entries.

### 4.2 Installation Procedure

Fig 4 illustrates the instrument installation procedure.

- a. Remove the instrument terminal cover by unscrewing the two captive 'A' screws.
- b. Mount the instrument on a flat surface and secure with two M6 screws through the 'B' holes. Alternatively use one of the mounting kits described in section 7.2
- c. Remove the temporary dust seals from the three cable entries and install the required glands, conduit fittings or blanking plugs.  
**Note:** The temporary dust seals fitted for transit do not maintain the IP66 protection of the BA684DF-P enclosure.
- d. Connect the field wiring to the terminals as shown in Fig 5.
- e. Replace the instrument terminal cover and evenly tighten the two 'A' screws.

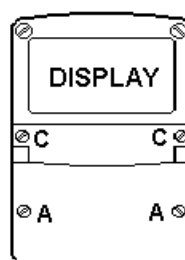

#### Step a

Remove the terminal cover by unscrewing the two 'A' screws

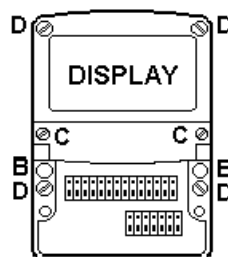

#### Step b

Secure the instrument to a flat surface with M6 screws through the two 'B' holes. Alternatively use a pipe mounting kit.

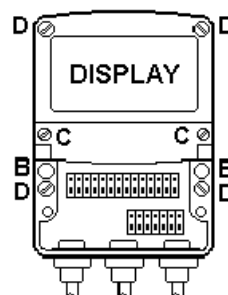

#### Steps c, d and e

Install appropriate IP rated cable glands, conduit fittings or blanking plugs and terminate field wiring. Finally replace the terminal cover and tighten the two 'A' screws.

Fig 4 BA684DF-P installation procedure

### 4.3 EMC

The BA684DF-P complies with the requirements of the European EMC Directive 2004/108/EC. For specified immunity, all wiring should be in screened twisted pairs with the screens connected to the plants potential equalising network.



## 5. DISPLAY & ALARM CONFIGURATION

In addition to loading the BA684DF-P PROFIBUS display GSD files onto the system host and defining up to eight fieldbus variables that are to be displayed, the instrument address, display and alarms, if fitted, have to be configured. How much of this configuration can be performed via the fieldbus depends upon the system host. Parameters that can not be configured via the fieldbus, may be set via the four front panel push buttons.

All the display and alarm configuration functions are contained in an easy to use menu that is shown in Fig 6. Where necessary the sub-menus contain on-screen prompts to guide the user through each adjustment.

When navigating through the configuration menu, the push-button(s) should be held until the required screen is displayed.

### 5.1 Default configuration

Unless otherwise requested at the time of ordering, BA684DF-P PROFIBUS displays will be supplied configured as follows:

Address	126
Keys	Both
Display brightness	100%
Display contrast	50%
Quick access menu	On
Quick access menu code	0000
Configuration menu access code.	0000
Screen	Single variable
Number format	Auto
All alarms	Disabled
Alarm activation	Good data only
Alarm outputs	N/C
Bargraph	
Low	0
High	100
Input scaling	
Zero offset	0
Gain factor	1
Status text	On
Last input	8

### 5.2 Accessing the display configuration menus

Throughout this manual the four BA684DF-P push buttons are identified **P** **E** **▼** **▲** and legends displayed by the instrument are shown within inverted commas e.g. 'Enter Access Code'.

Operating the **P** and **E** push buttons simultaneously accesses the display configuration menu. If the BA684DF-P is not protected by an access code the main menu will be displayed. If an access code other than the default code 0000 has already been entered, the BA684DF-P will request that the access code be entered.

Using the **▼** or **▲** button adjust the first digit of the code which will be flashing. Pressing **P** will transfer control to the next digit, which should be adjusted in the same way. When all four digits have been set, pressing the **E** button will enter the access code. If the code is correct the main menu will be displayed, if the code is incorrect 'Invalid Code' will be displayed.

When entering an access code, timeout will occur and the instrument will automatically return to the operating mode ten seconds after a push button was last operated. In all other menus, timeout occurs after sixty seconds.

The structure of the display configuration menu is shown in Fig 6. Navigation is achieved by highlighting the required function using the **▼** and **▲** buttons and then operating the **P** button to display the selected function sub-menu, from which a further selection or adjustment may be made. Operating the **E** button moves the display back up one level.

A flashing highlight indicates that an option or alphanumeric character may be selected using the **▼** and **▲** buttons and entered using the **E** button. If only one entry or adjustment can be made in a sub-menu, the display will automatically move up one menu level when the adjustment is entered. If more than one adjustment can be made in a sub-menu, the highlight may be moved to the second variable using the **▼** or **▲** button after the first setting has been entered. Operating the **P** button allows the second variable to be adjusted.

When multiple numeric or alpha characters are adjusted e.g. an alarm setpoint or a tag legend, the adjustment is made one digit at a time using the **▼** and **▲** buttons. After the first flashing digit has been set as required, the flashing highlight can be moved to the next digit by operating the **P** button. When all digits have been set, operating the **E** button will enter the setting.

Following completion of the instrument configuration, the **E** button should be operated to step the display back to the main menu. One more operation of the **E** button will then return the BA684DF-P to the operating mode.



**5.3 Configurable functions**

This section provides an explanation of each configurable function and should be read in conjunction with Fig 6. See section 5.3.11 for entering the instrument's PROFIBUS PA address.

**5.3.1 Screens (Display format)**

The BA684DF-P can display up to eight fieldbus variables that are identified as IN\_1 to IN\_8. The fieldbus variable that each one represents is determined by the BA684DF-P configuration at the fieldbus system host - see the *PROFIBUS Fieldbus Interface Guide* which may be downloaded from the BEKA website.

This sub-menu allows one of eleven standard display formats to be selected. The standard formats contain one, two, three, four or eight fieldbus variables some with bargraphs as shown below.

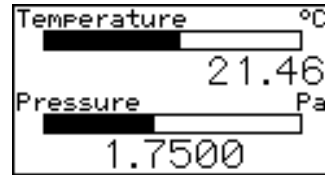

Two variables + horizontal bargraphs

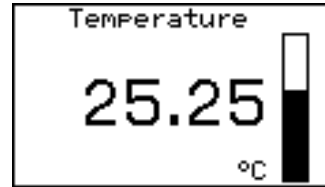

One variable + vertical bargraph

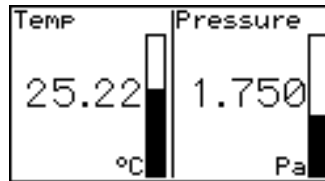

Two variables + vertical bargraphs

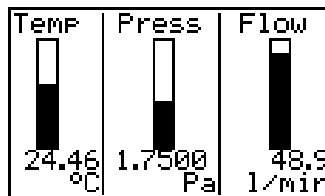

Three variables + vertical bargraphs

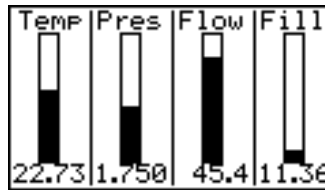

Four variables + vertical bargraphs

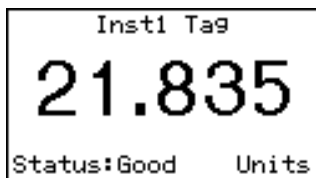

One variable

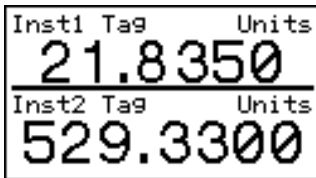

Two variables

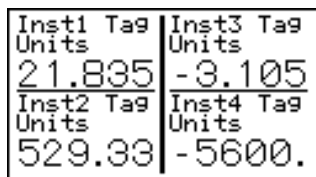

Four variables

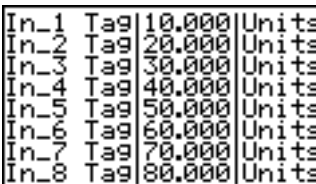

Eight variables

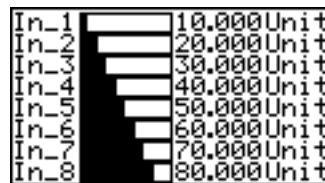

Eight variables + horizontal bargraphs

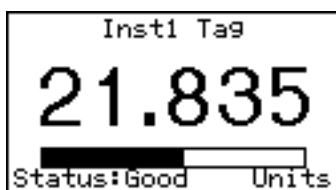

One variable + horizontal bargraph

### 5.3.2 Input Settings

Each of the eight fieldbus variable inputs may be scaled before being displayed as shown below.

$$\text{Display} = (\text{Gain} \times \text{Fieldbus variable}) + \text{Offset}$$

The sub-functions for each of the eight inputs are:

**'Offset'** Adds a positive or negative offset to the fieldbus variable before it is displayed.

**'Gain'** Multiplies the fieldbus variable by a factor before it is displayed.

**'Bar Lo'** Defines the bargraph lower limit

**'Bar Hi'** Defines the bargraph higher limit

**'Format'** Defines the position of the displayed decimal point.

Six options are available:

Auto: Max resolution with selected display format.

4 DP 4 digits on right of decimal point

3 DP 3 digits on right of decimal point

2 DP 2 digits on right of decimal point

1 DP 1 digit on right of decimal point

0 DP No decimal point

The total number of display digits available depends upon the display screen selected – see 5.3.1

Screen	Description	Digits
1	1 variable	5, 7, 11 or 17*
2	2 variables	7
3	4 variables	5
4	8 variables	5
5	1 variable + H bar	5, 7, 11 or 17*
6	2 variables + H bars	7
7	1 variable + V bar	6
8	2 variables + V bars	4
9	3 variables + V bars	6
10	4 variables + V bars	4
11	8 variables + H bars	5

\* Font automatically resizes in auto mode

If a negative number is likely to be displayed, a digit must be allocated for the negative sign. If the display overranges all the digits will display '?'.  
 For all options leading zeros, apart from the zero in front of a decimal point, are automatically suppressed.

### 5.3.3 Tags

Each of the eight fieldbus variables may be displayed with an individual tag that can contain up to sixteen alphanumeric characters. This menu allows these tags to be entered. After selecting the required variable, the tag legend is entered character by character using the ▼ and ▲ push buttons. Numbers, upper & lower case letters and symbols are available.

### 5.3.4 Units

Each of the eight fieldbus variables may be displayed with units of measurement that can contain up to eight alphanumeric characters. This menu allows these units of measurement to be entered. After selecting the required variable, the unit of measurement is entered character by character using the ▼ and ▲ push buttons. Numbers, upper & lower case letters and symbols are available.

### 5.3.5 Alarms

**Alarm menus are only included when the BA684DF-P is fitted with optional alarm outputs. Outputs are locally activated from the fieldbus variables and are configured via the instrument menus and push buttons. They can not be controlled via the fieldbus.**

Each of the six alarms may be linked to any one of the eight fieldbus variables displayed by the BA684DF-P. Each alarm output can be conditioned to function as a high or a low alarm, or as a combined high and low alarm. The output can be conditioned as normally open 'N/O' or normally closed 'N/C' in the non-alarm condition. Irrespective of settings all alarm outputs will be open when the instrument is not powered from the fieldbus.

When an alarm is activated, the associated fieldbus variable display flashes, i.e. alternates between dark figures on a light background and light figures on a dark background.

There are eight alarm-conditioning sub-menus.

#### 5.3.5.1 Alarm Summary

Shows to which PROFIBUS variable each alarm is linked and how each alarm has been conditioned. i.e. high, low, or combined high & low alarm with normally open or closed output. No adjustments can be made via this sub-menu.

### 5.3.5.2 Alarm Activation

PROFIBUS variables that have not been validated are displayed with dark characters on a light background, and some screen formats also contain a status indication. This sub-menu allows the alarm outputs to be conditioned so that they only operate with validated PROFIBUS data, or to operate irrespective of data validity.

### 5.3.5.3 Alarm Output

There is a separate sub-menu for each of the six alarm outputs; these link the alarm to one of the displayed fieldbus variables and define the alarm function and the setpoints.

To link the alarm to a displayed variable, position the highlight over the 'IN\_n' field, press **P** and using the ▼ or ▲ button select the required input source. Enter the selection by pressing the **E** button.

Each alarm output can be N/O or N/C in the non-alarm condition. To change the setting, position the highlight over the 'N/O or N/C' field, press **P** and use the ▼ or ▲ button to toggle the setting. Enter the selection by pressing the **E** button.

Each alarm output has three functions that can be independently enabled to condition the output as a low or high alarm, or as a combined low and high alarm, either with or without hysteresis.

The required functions can be individually enabled by positioning the highlight over the Enb/Dis (Enabled/Disabled) column, pressing **P** and toggling the function to the required state, then entering the selection by pressing the **E** button.

Alarm setpoints are entered digit by digit. Place the highlight over the setpoint to be adjusted and press **P**; the flashing digit to be adjusted may then be selected by again pressing **P**. When all the digits have been adjusted, operating the **E** button enters the value and moves the menu up one level.

The function of all alarms may be reviewed from the alarm summary menu - see 5.3.5.1.

## 5.3.6 Display

### 5.3.6.1 Settings

The backlight brilliance and display contrast are adjustable from this sub-menu.

### 5.3.6.2 Quick Access

This sub-menu enables the Quick Access Menu which is described in sections 2.1 and 5.4. When enabled, an operator can adjust the display contrast and backlight brilliance without having access to any other conditioning menus.

### 5.3.6.3 Access Code

Defines a four digit alphanumeric code that must be entered to gain access to the Quick Access Menu. Alpha characters are case sensitive. Default code 0000 allows direct access without a code.

### 5.3.6.4 Status Text

The two single variable screens 1 and 4 will show the status of the PROFIBUS variable as 'Good' or 'Bad' if the Status Text function is activated.

### 5.3.6.5 Last Input

This function allows the maximum number of PROFIBUS variables to be defined so that unused inputs are skipped when the display is scrolled in the operating mode.

## 5.3.7 Keys

The function of the front panel push buttons may be transferred to four of the six optional external push buttons, with or without disabling the BA684DF-P front panel push buttons. The table below shows the function of the BA684DF-P front panel and the external push buttons for each of the four options that may be selected in the Keys sub-menu.

Selected option from Keys sub-menu	Push buttons	Function of push buttons			
		Screen scrolling	P+E access to configuration menu	P+Up access to quick access menu	Return Key_Status to host
Internal	BA484DF	Yes	Yes	Yes	Yes*
	External	No	No	No	No
External	BA484DF	No	Yes	No	No
	External	Yes	Yes	Yes	Yes*
Both	BA484DF	Yes	Yes	Yes	Yes*
	External	Yes	Yes	Yes	Yes*
Internal + Port	BA484DF	Yes	Yes	Yes	No
	External	No	No	No	Yes*

\* Apart from when 'Internal+Port' is selected, the Key\_Status does not function when the instrument is in the configuration menu.

The fourth option 'Internal + Port' allows the front panel push buttons to be used for controlling the BA684DF-P PROFIBUS display and the optional external push buttons to independently enter operator acknowledgements or controls. This option also allows the status of plant mechanical switches to be returned to the host using the DI function blocks.

For applications where the instrument is only displaying 1, 2, 3, 4 or 8 variables on a single screen, it is recommended that external buttons are selected but not fitted. This will disable the instrument front panel buttons, but still provide access to the configuration menu, which may be protected by a security code.

### 5.3.8 Code

Defines the four digit alphanumeric code that must be entered to gain access to the instrument configuration menus. Alpha characters are case sensitive. Default code 0000 allows direct access without a code.

### 5.3.9 Unit Info

Displays the instrument model number and the software version.

### 5.3.10 Defaults

This function enables the display and interface board factory defaults to be restored.

#### 5.3.10.1 Display Defaults

This function restores the display defaults defined in section 5.1.

#### CAUTION

**Existing settings can not be recovered after this function has been used.**

#### 5.3.10.2 Interface Board Defaults

This function restores the Fieldbus Interface Board factory defaults.

#### CAUTION

**Do not use this function when the BA684DF-P is connected to an operational PROFIBUS network, as communication to the display will be terminated.**

### 5.3.11 Instrument address

Enables the required three digit PROFIBUS address to be entered digit by digit using the instrument's push buttons.

### 5.4 Quick Access Menu

The Quick Access Menu allows an operator to adjust the backlight brilliance and the display contrast without having access to the other configuration parameters.

The quick access menu is accessed by operating the **P** and **▲** push buttons simultaneously. If the Quick Access Menu is not protected by an access code the contrast and brilliance controls will be displayed immediately. If an access code other than the default code 0000 has already been entered, the BA684DF-P PROFIBUS display will request that the access code be entered.

The display backlight brilliance is adjusted using the **▼** and **▲** push buttons. Operating the **P** push button will transfer control to the display contrast adjustment. When both are set as required, operating the **E** button will store both settings and return the instrument to the operating mode.

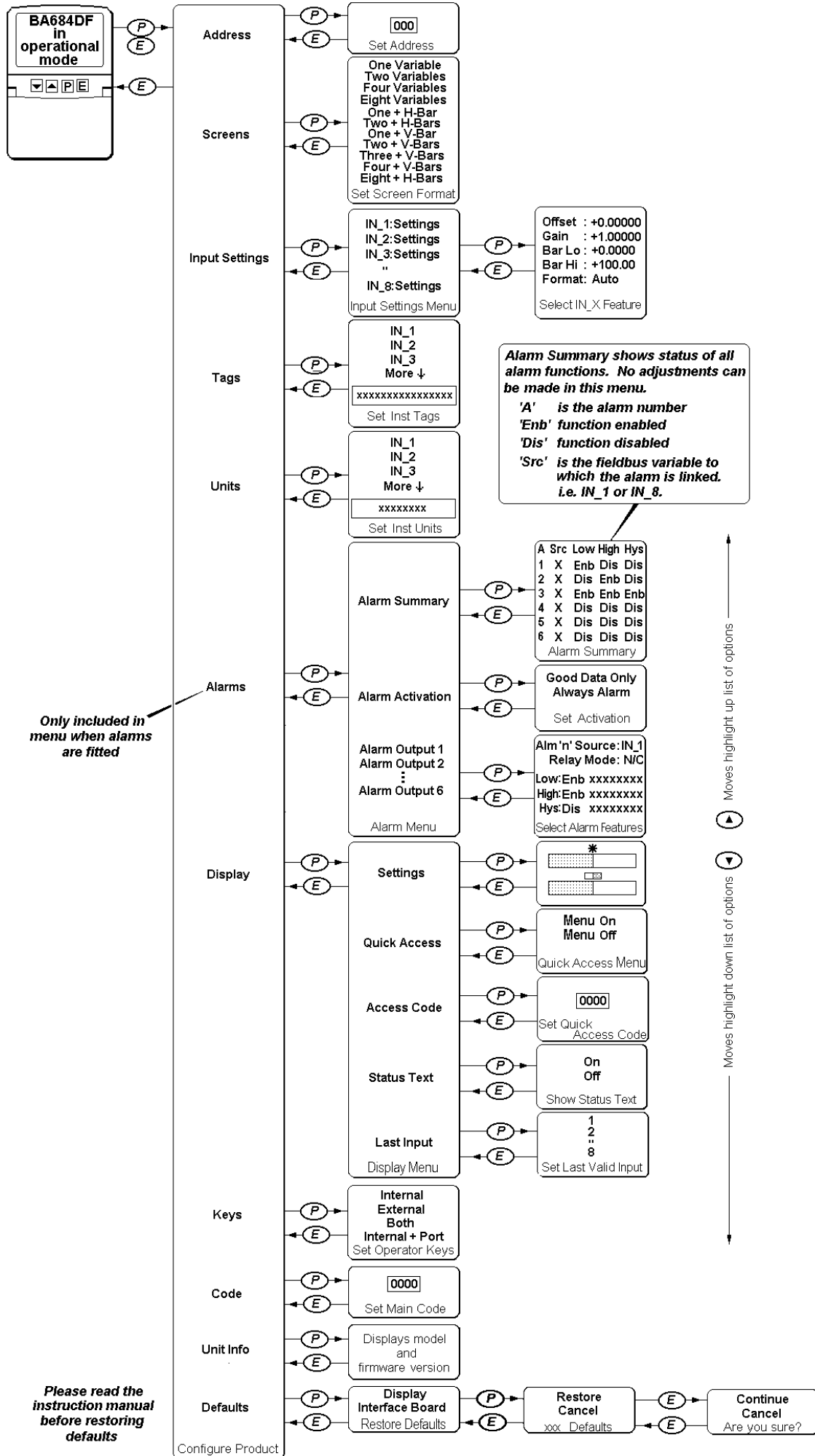

Fig 6 Structure of Configuration Menu

## 6. MAINTENANCE

### 6.1 Fault finding during commissioning

If a BA684DF-P PROFIBUS displays fails to function during commissioning the following procedure should be followed:

Symptom	Cause	Check:
No Display	Fieldbus not powered	9 to 32V between terminals 1 & 2.
No variables	Fieldbus not configured	Instrument configuration at host
Wrong variable displayed	Wrong screen selected	Other screens by operating <i>Up</i> or <i>Down</i> button
Display shows '????'	Display overrange	Number format see section 6.3.2
No backlight	Brilliance turned down	Setting in display menu
Low or excessive contrast	Incorrect contrast setting	Setting in display menu
Displayed variable is inverted i.e. light digits on dark background	Variable has 'bad' status	Configuration and instrument supplying variable
Displayed variable is flashing	Associated alarm has been activated	Setpoints
Bargraph on standard display format is shown dotted	Displayed fieldbus variable is outside bargraph limits or data is 'bad'	Bargraph limits see section 5.3.2

### 6.2 Fault finding after commissioning

#### ENSURE PLANT SAFETY BEFORE STARTING MAINTENANCE

If a BA684DF-P PROFIBUS display fails after it has been functioning correctly, the table shown in section 6.1 may help to identify the cause of the failure.

If this procedure does not reveal the cause of the fault, it is recommended that the instrument is replaced.

### 6.3 Servicing

We recommend that faulty BA684DF-P PROFIBUS displays are returned to BEKA associates or to our local agent for repair.

### 6.4 Routine maintenance

The mechanical and electrical condition of the instrument should be regularly checked. Initially annual inspections are recommended, although the inspection frequency should be adjusted to suit the environmental conditions.

### 6.5 Guarantee

Instruments which fail within the guarantee period should be returned to BEKA associates or our local agent. It is helpful if a brief description of the fault symptoms is provided.

### 6.6 Customer comments

BEKA associates is always pleased to receive comments from customers about our products and services. All communications are acknowledged and whenever possible, suggestions are implemented.

## 7. ACCESSORIES

### 7.1 Tag plate

The BA684DF-P PROFIBUS display can be supplied with a blank or custom engraved stainless steel plate secured by two screws to the side of the instrument enclosure. This plate can accommodate:

1 row of 9 alphanumeric characters 10mm high

or 1 row of 11 alphanumeric characters 7mm high

or 2 rows of 18 alphanumeric characters 5mm high

### 7.2 Pipe mounting kits

Two pipe mounting kits are available for securing the BA684DF-P PROFIBUS display to a horizontal or vertical pipe.

BA392D Stainless steel bracket secured by two worm drive hose clips for 60 to 80mm outside diameter pipes.

BA393 Heavy duty stainless steel bracket secured by a single 'V' bolt. Will clamp to any pipe with an outside diameter between 40 and 80mm.

### 7.3 PROFIBUS Interface Guides

The BEKA PROFIBUS Interface Guide, which may be downloaded from the BEKA web site at [www.beka.co.uk](http://www.beka.co.uk) contains conditioning information for all BEKA PROFIBUS products.

**8. INDEX**

<b>Subject</b>	<b>Section</b>	<b>Subject</b>	<b>Section</b>
Address	5.3.11	Number Format	5.3.2
Alarms	5.3.5	Pipe mounting kits	7.2
Activation	5.3.5.2	PROFIBUS PA	1; 2
Output	5.3.5.3	Quick access menu	5.3.6.2; 5.4
Summary	5.3.5.1	Servicing	7.3
Backlight	5.3.6.1	Screens (display format)	5.3.1
Bargraph limits	5.3.2	Tags	5.3.3
Configuration menu	Fig 6	Tag plate	7.1
Controls	2.1	Terminal numbers	Fig 5
Code	5.3.8	Units (of measurement)	5.3.4
Decimal Points	5.3.2	Unit Info (firmware version)	5.3.9
Default settings	5.1; 5.3.10		
Display	5.3.6		
Access code	5.3.6.3		
Settings	5.3.6.1		
Quick access	5.3.6.2; 5.4		
EMC	4.3		
External switches	3.1; 5.3.7		
Fault finding			
During commissioning	7.1		
After commissioning	7.2		
Fieldbus connection	3		
FOUNDATION fieldbus™	1		
Guarantee	7.5		
Input scaling	5.3.2		
Installation	4		
Keys	5.3.7		
Location	5.1;		
Maintenance	7.		
Routine	7.4		